

All in One Hyper Series Hyper-3000

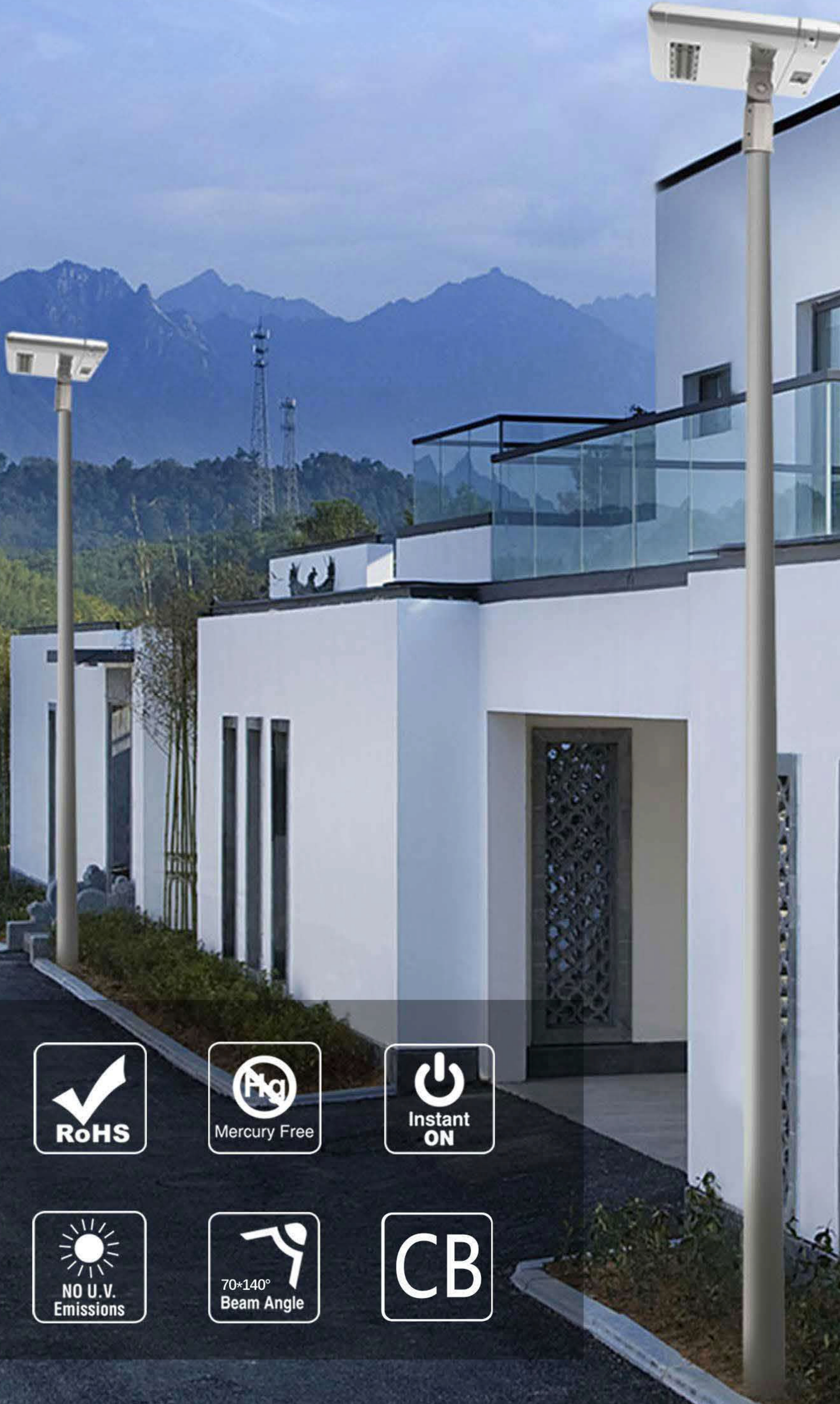

COMM LIGHTING

www.comm.com.tr



Hyper-3000

SPECIFICATION

Lighting

Light output	3000-5000LM
LED Chip	5050
CCT	2700-6000K (can be customized)
Optical Efficiency	>93%
Life Span	100,000 hours to LM80 specifications
Working Way	Motion Sensor/IOT/Time Schedule

Solar Panel

Power of PV module	40W
Life Span	25 years

Storage

Battery Capacity	280WH
Life Span	4000 cycles (10 years)

Charging Controller

Life Span	>12years
Working Mode	MPPT
Control Mode	Intelligent,activated by sunlight

Mechanical Specifications

Recommended Top diameter of the Pole	60mm
Recommened Pole Height	3m-6m
Product Dimension (mm)	457*406*84mm
Weight (Kg)	11kg(Approx)

Environment

Working Temperature	-15°C to +70°C
Water Resistance	IP65

Hyper-3000

WORKING MODE (can be customized)

< 1 >

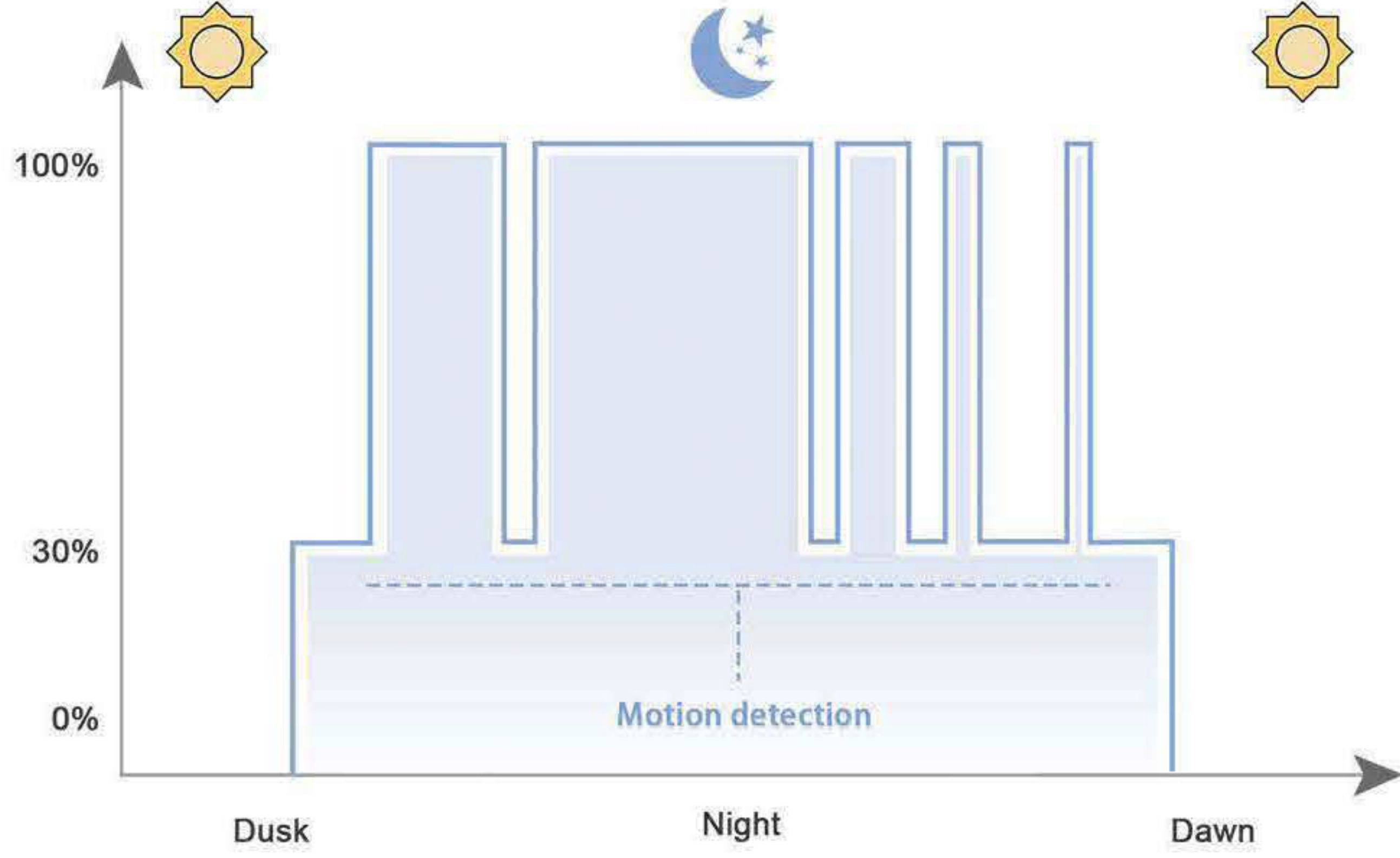

(30% brightness + motion detection till dawn)

< 2 >

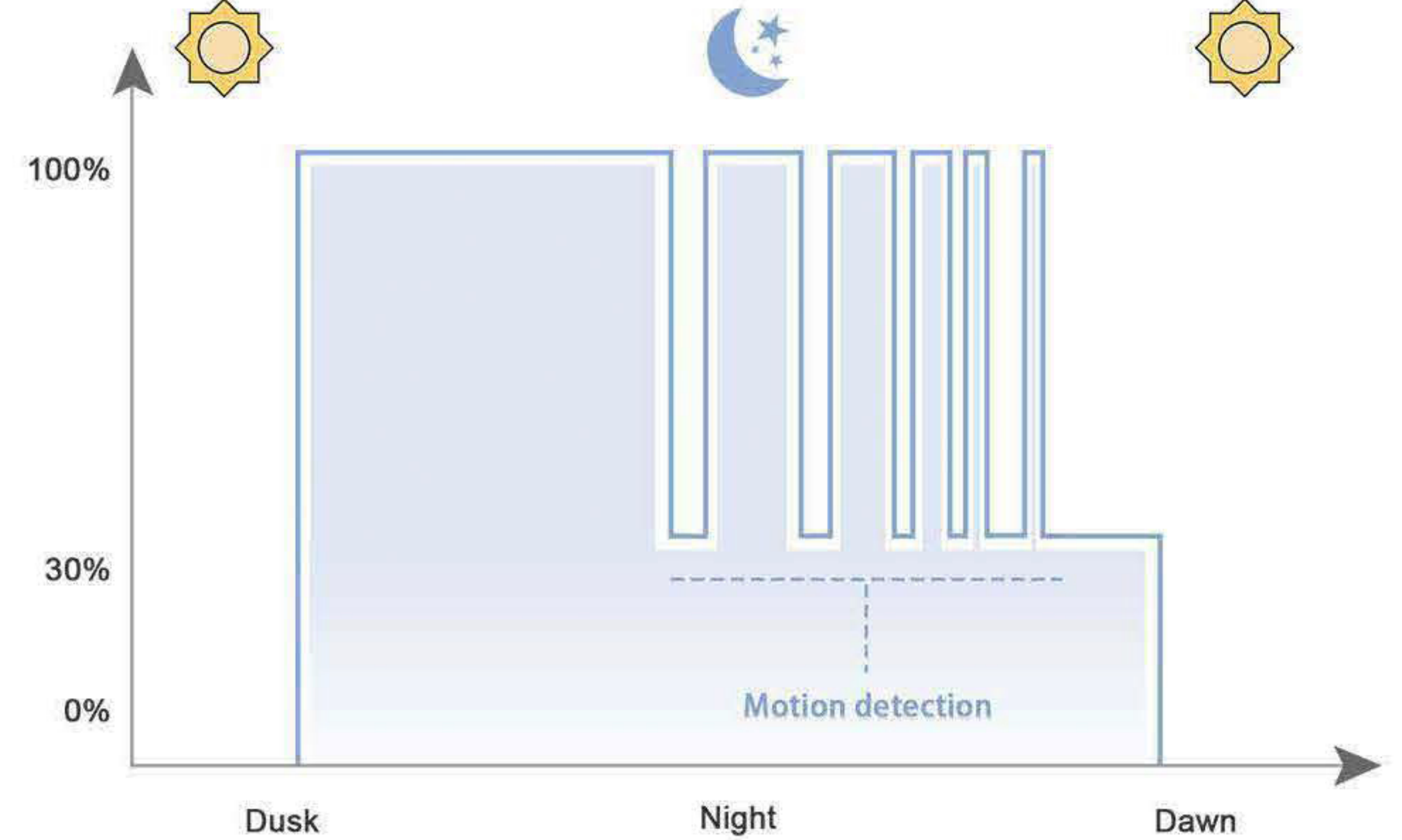

(5hours 100% brightness+30% brightness with motion detection till dawn)

< 3 >

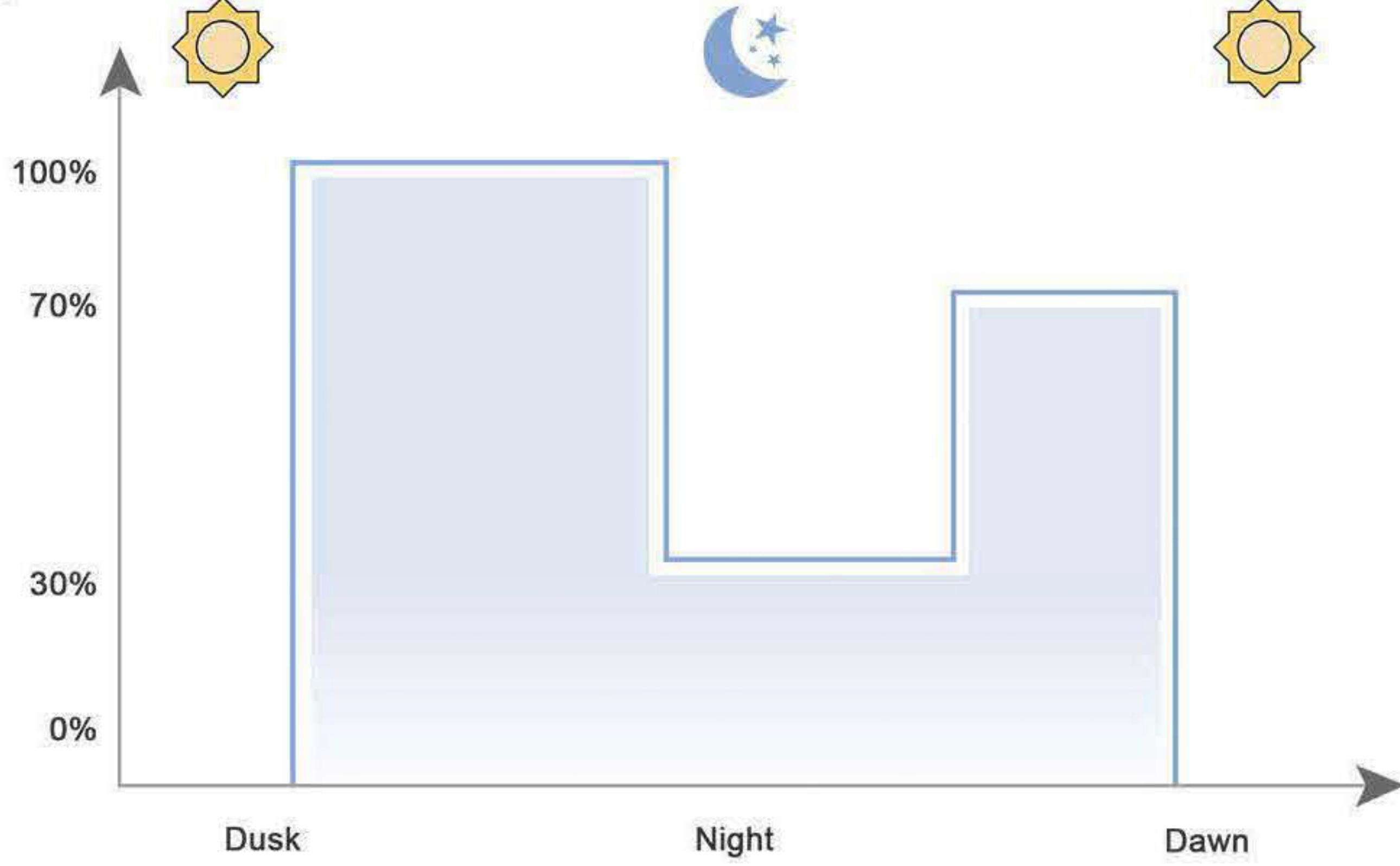

(5hours 100% brightness+4 hours 30% brightness+70% brightness till dawn)

< 4 >

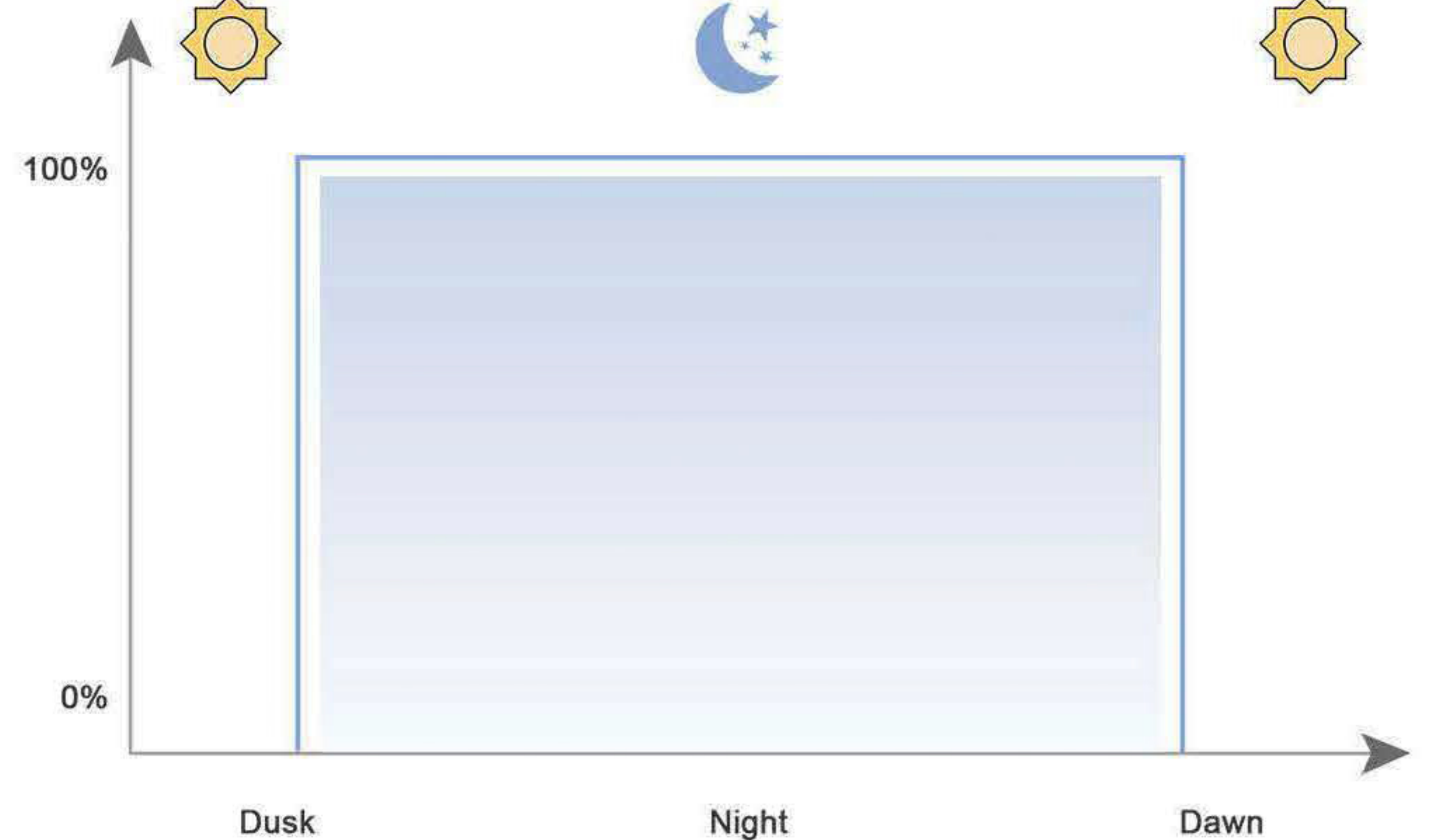

(100% brightness till dawn)

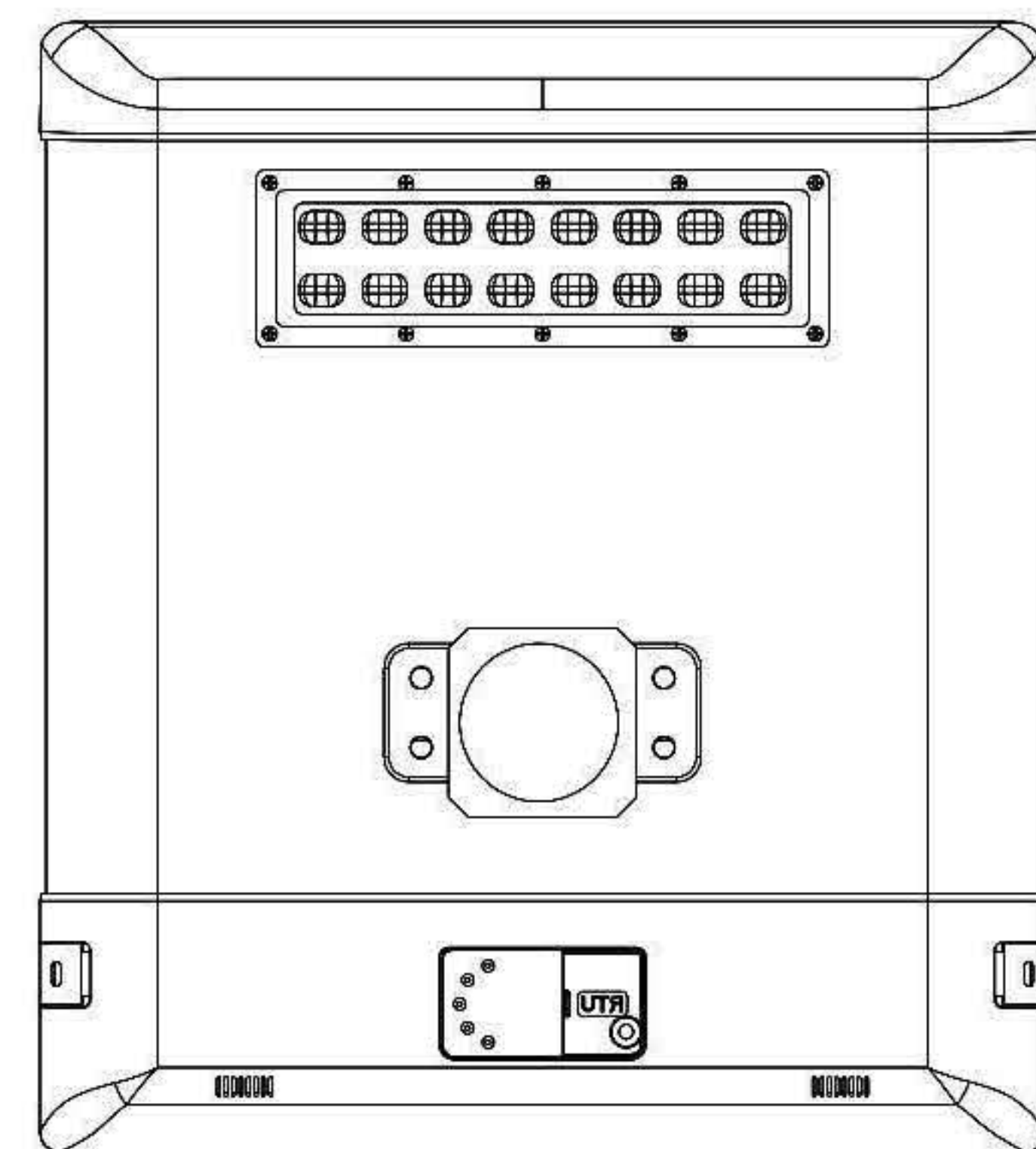
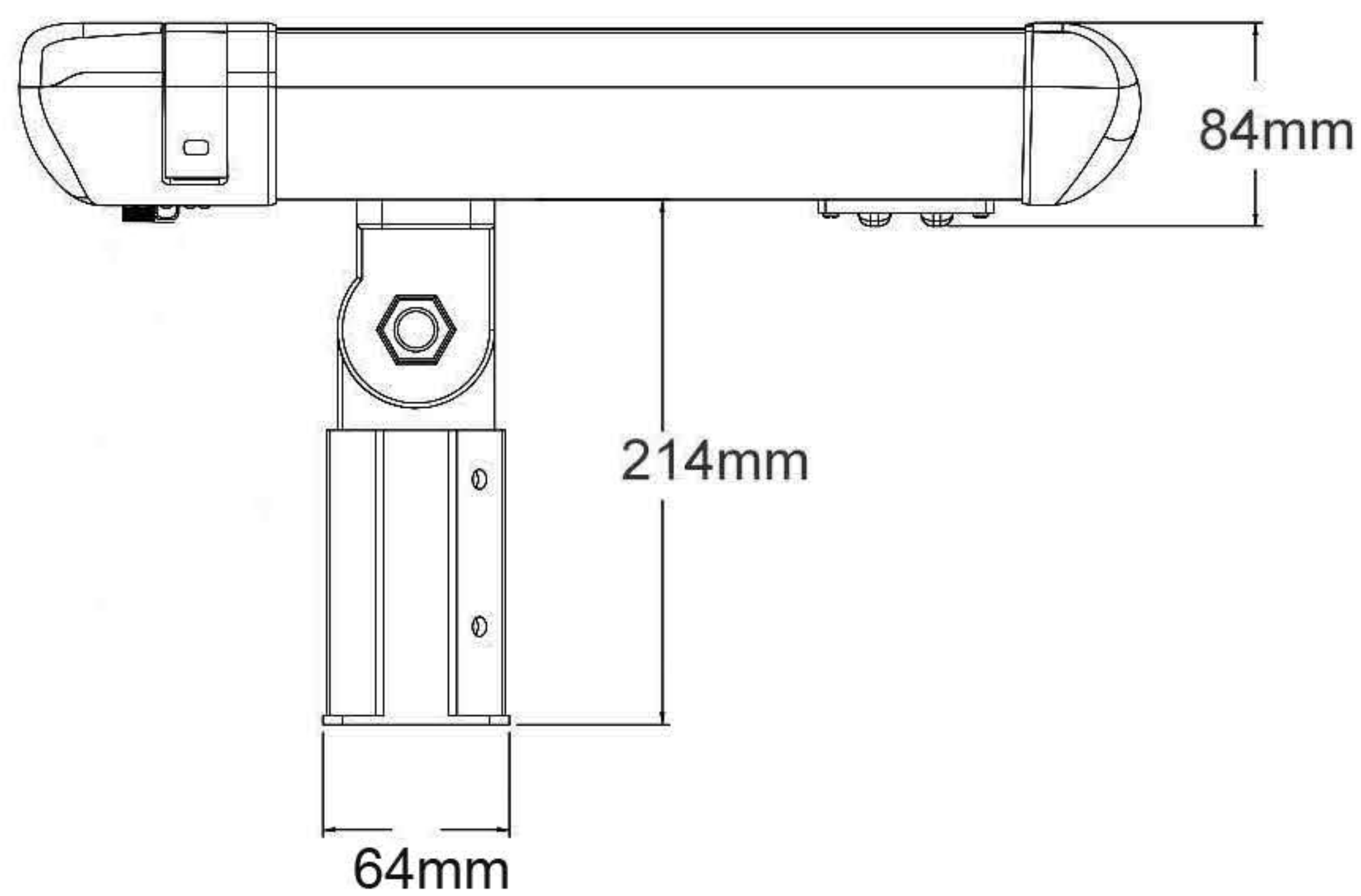

Hyper-3000

| ADVANTAGES



Hyper-3000

| MORE DETAILS



All aluminium alloy design

www.comm.com.tr

Hyper-3000

| ADVANTAGES



Buckle design, Easy-to-install
Tools-free-maintain

www.comm.com.tr

Hyper-3000

| ADVANTAGES

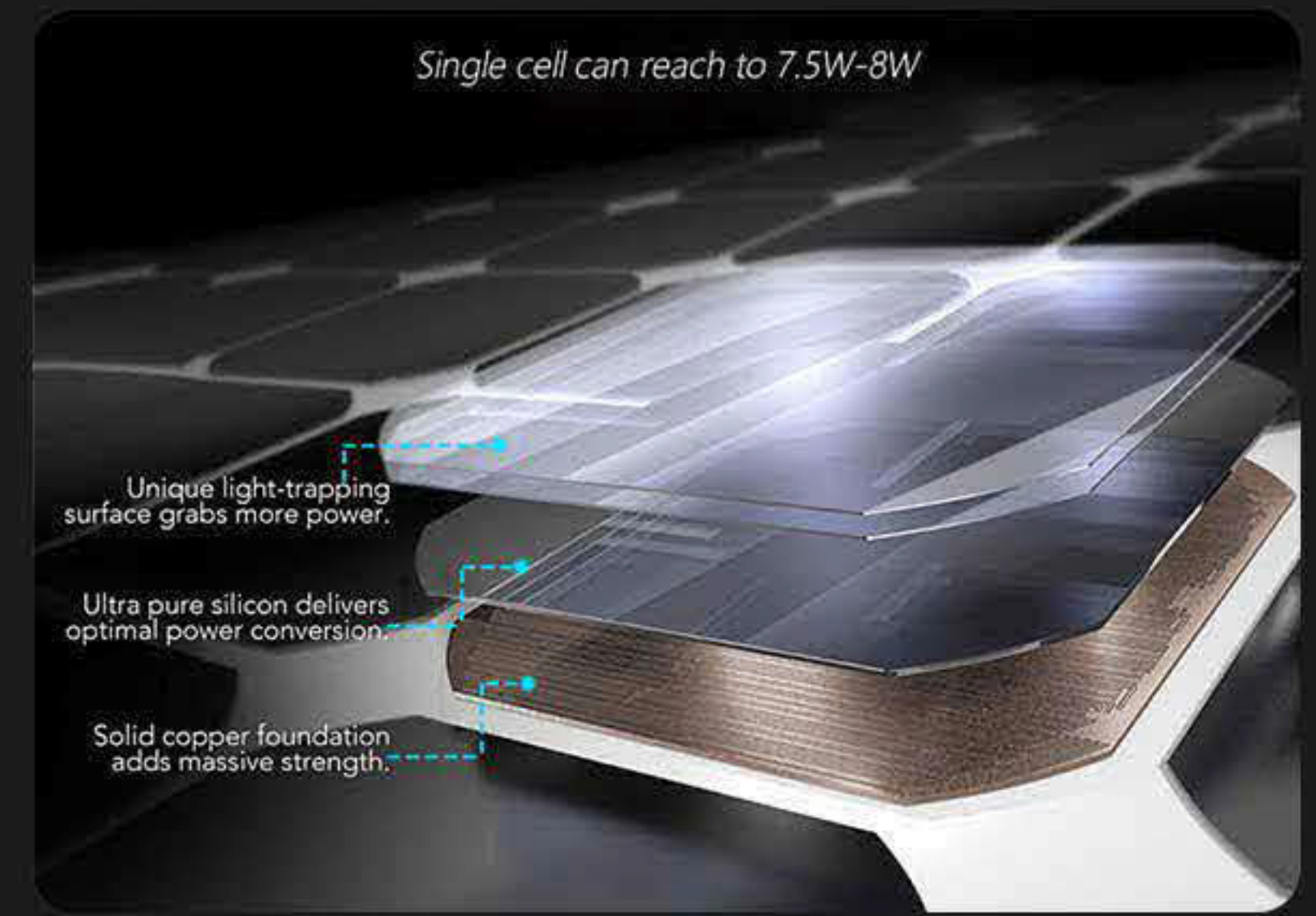

High-efficiency solar panels



Buckle design

Hyper-3000

| CORE TECHNOLOGY



OURS



OTHER

Overall aluminum heat dissipation

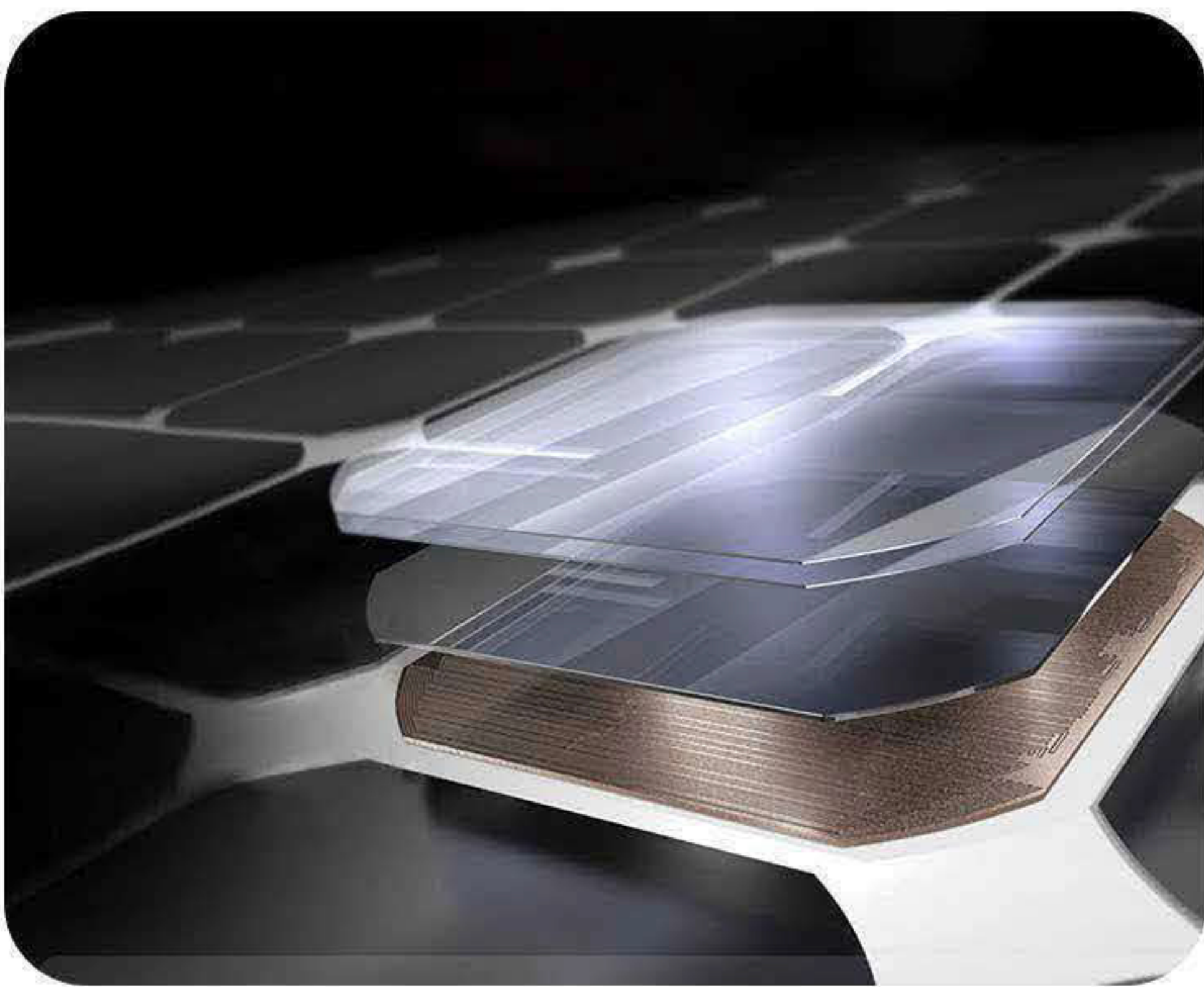
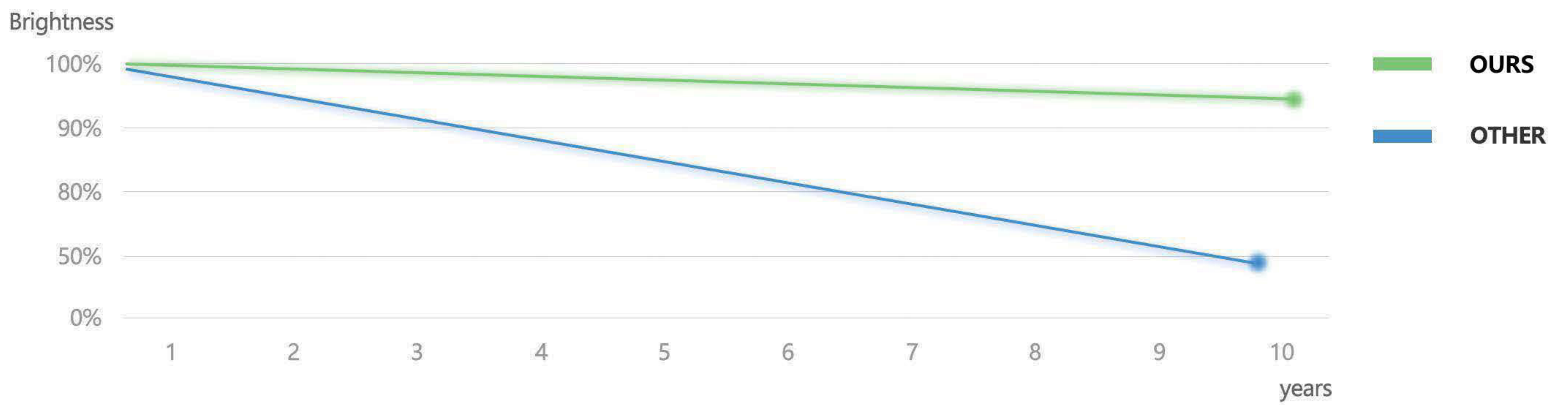

OURS-40W



OURS-40W

PV Advantage

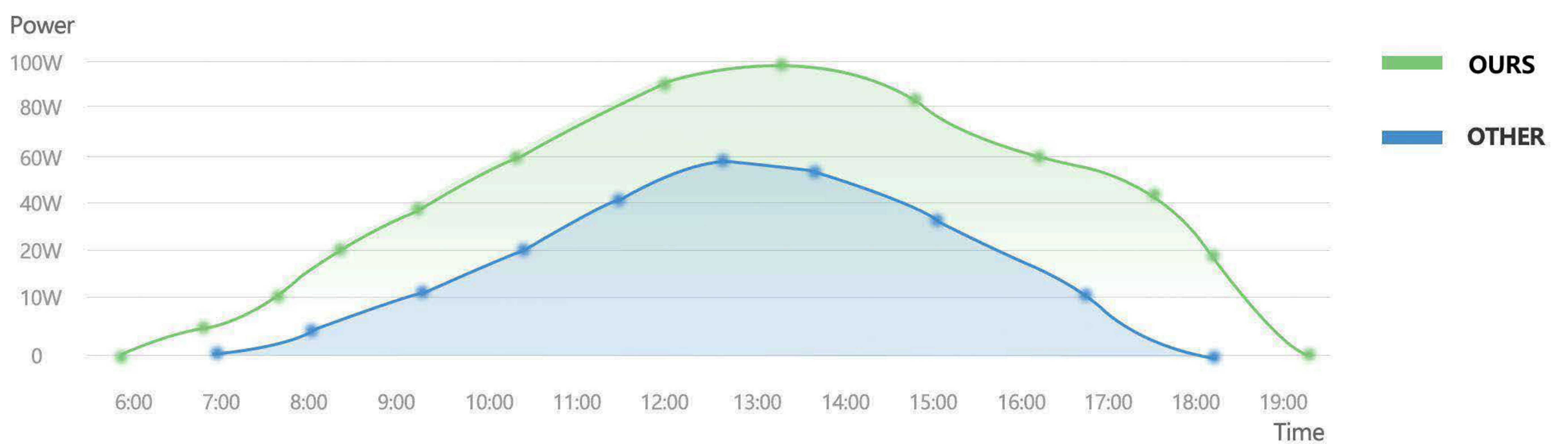

Hyper-3000

SOLAR STREET LIGHT

www.comm.com.tr



Phone : + 90 312 267 03 34
info@comm.com.tr